

# DBcaps® Capsule Dimensions

## Double-Blind Clinical Trial Capsules

### SIZE AAA

Wt. 199.5mg ±12  
Capsule Vol. 1.44 ml

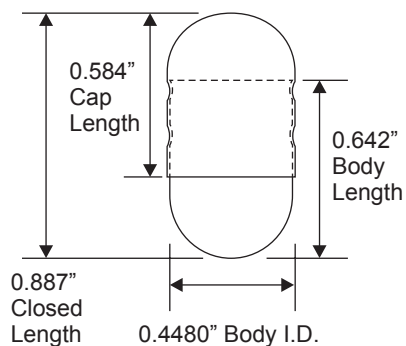

### SIZE AAel

Wt. 171mg ±14  
Capsule Vol. .97 ml

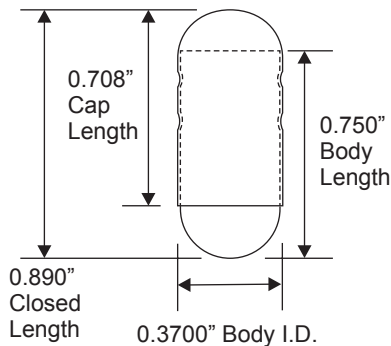

### SIZE AA

Wt. 138mg ±14  
Capsule Vol. .80 ml

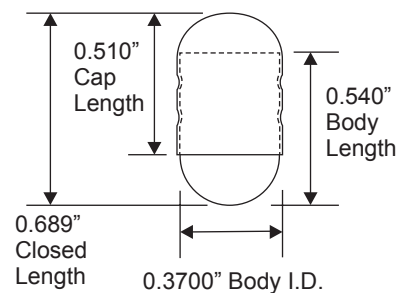

### SIZE A

Wt. 114mg ±9  
Capsule Vol. .68 ml

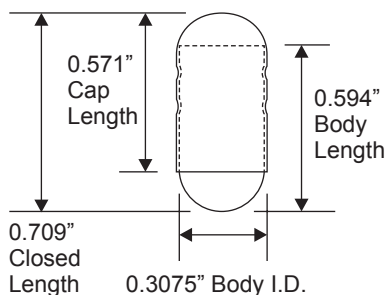

### SIZE B

Wt. 82mg ±7  
Capsule Vol. .50 ml

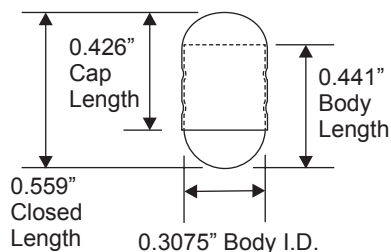

### SIZE C

Wt. 72mg ±6  
Capsule Vol. .37 ml

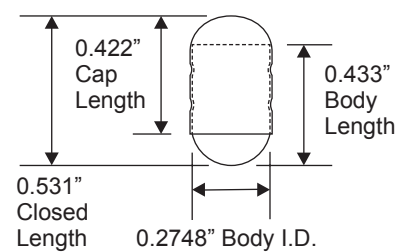

### SIZE D

Wt. 59mg ±5  
Capsule Vol. .30 ml

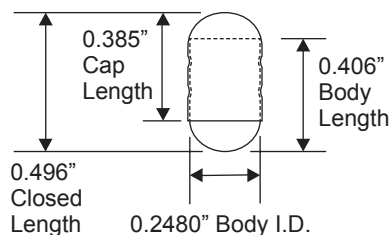

### SIZE E

Wt. 47mg ±4  
Capsule Vol. .21 ml

